



Folders and Holders Guide

A guide to Richprint's most popular sized and shaped folders and holders.



www.richprintonline.co.uk

Folders and holders... an excellent way of improving your presentation

This guide shows some of our most popular shapes and styles, however, we can make any shape of folder to order. Larger capacity folders are also available on request.

You have the choice of using Richprint's designers to create your folder or you can provide your own design on disk. If you are supplying your own artwork, a guide can be supplied for you to design within. With over 30 years in the trade you can be assured of exceptional designs and a professional service at a cost to suit any budget.

Why not have matching business cards produced at the same time – all you pay is the cost of setting and cutting the cards, the run will be supplied free!

The benefits

- keep your literature neat and tidy
- enhance your corporate image
- hold information about products or services, tenders or technical data
- allow you to have a professional cover for documents you create on your computer
- ability to change inserts without the cost of changing the cover
- can be used indefinitely providing the design is kept generic

Special finishes

Enhance the feel and prolong the life of your folder by mixing and matching from the following:

- Gloss Laminate
- Spot Gloss Varnish
- Foil Blocking
- Matt Laminate
- Spot Matt Varnish
- Blind Embossing

As a guide

The Richprint folder is printed on 350gsm silk art board, matt laminated both sides with a spot UV gloss varnish to front cover.

The Richprint sample box is printed on 330gsm folding boxboard, with a matt laminate & spot UV gloss varnish to one side only.

This guide contains many formats but if you have an alternative in mind, please call us to discuss your requirements.

Small folders and pockets

A6, A5 and DL

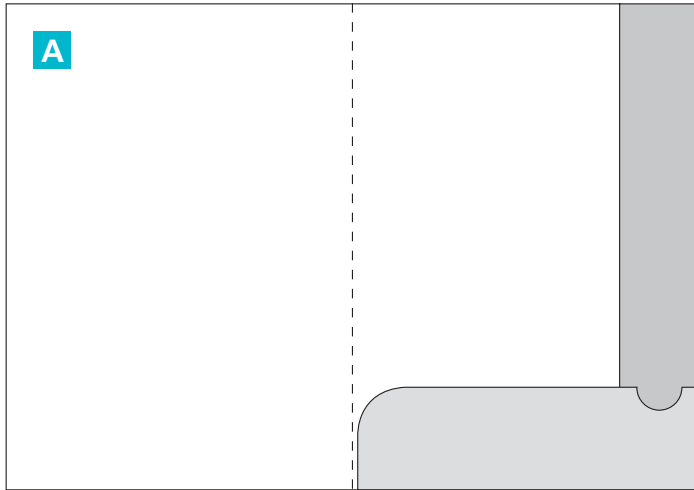

A5 | Clip together style

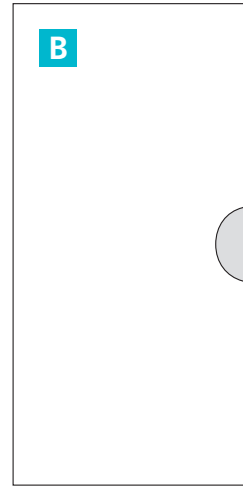

DL | Glued pocket style

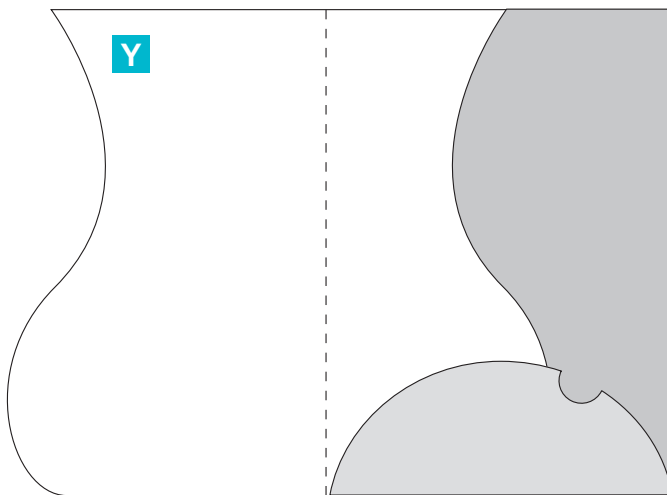

A5 | Clip together style

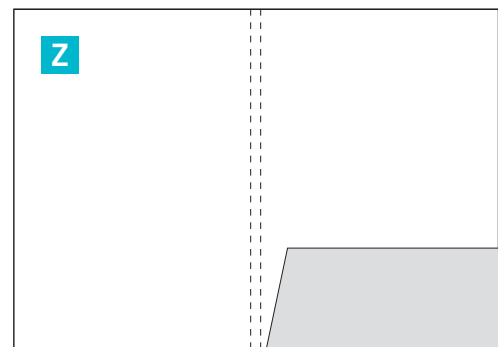

A6 | 4mm capacity glued pocket style

CD holders and pockets

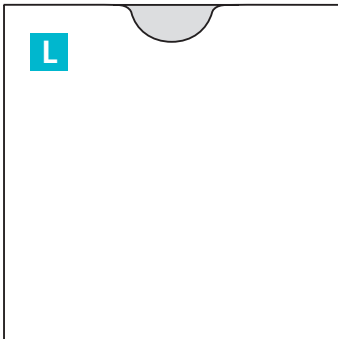

CD | Pocket

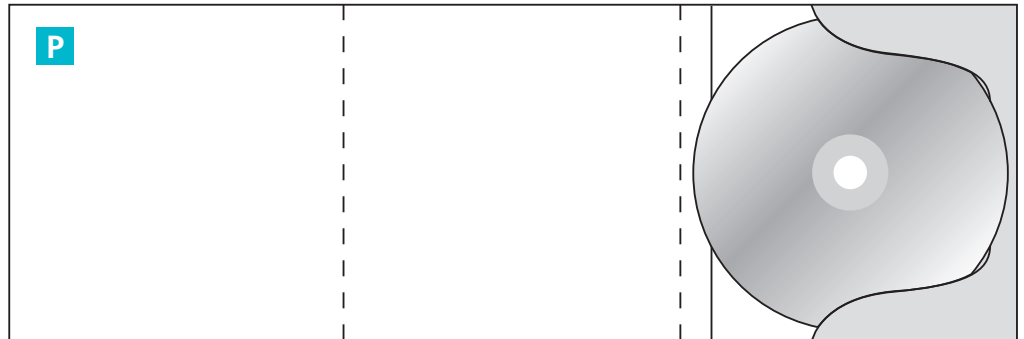

CD | 3 fold holder

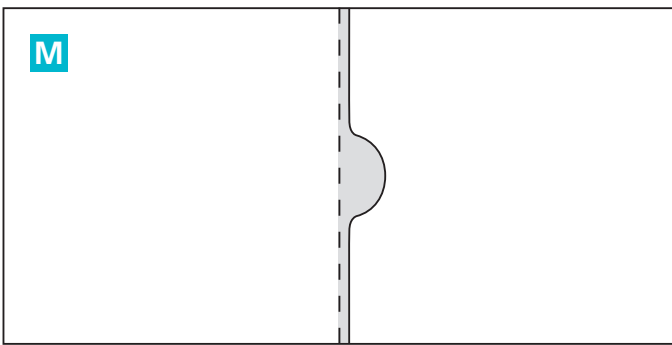

CD | Double fold pocket

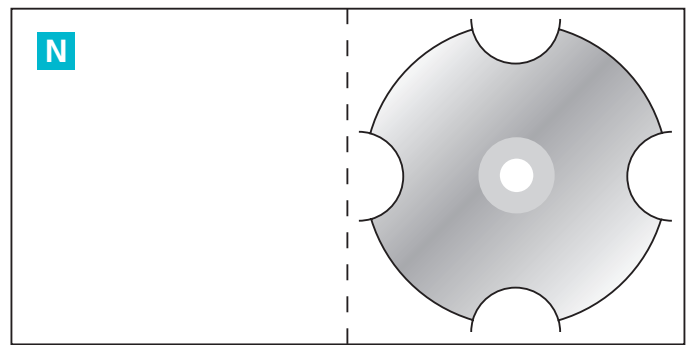

CD | Double fold holder

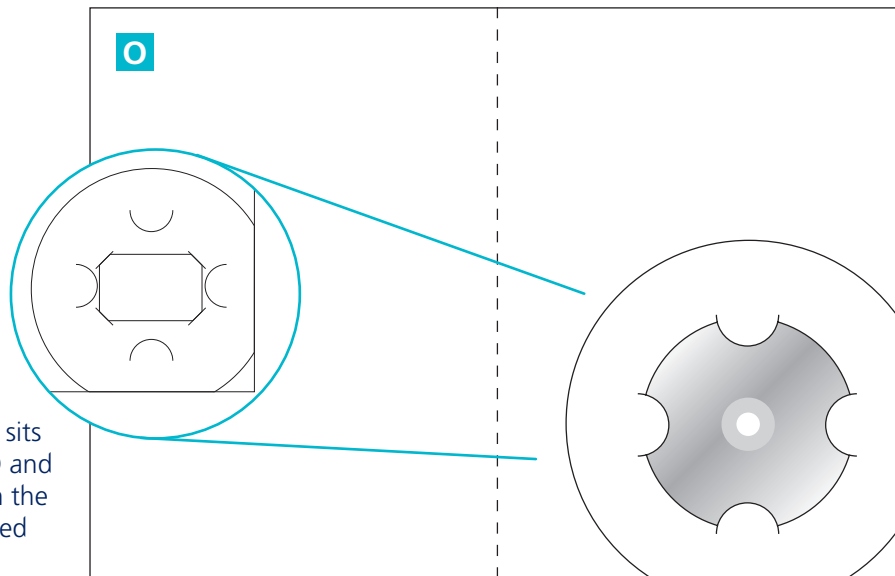

Business card sits behind the CD and is visible when the CD is removed

A4 | Folder with CD and landscape business card holder

A4 capacity folders

Glued style

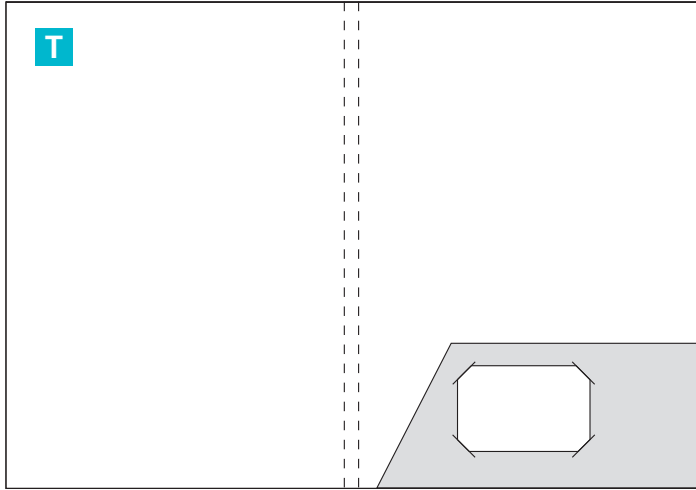

A4 | 4mm capacity glued pocket style (landscape business card)

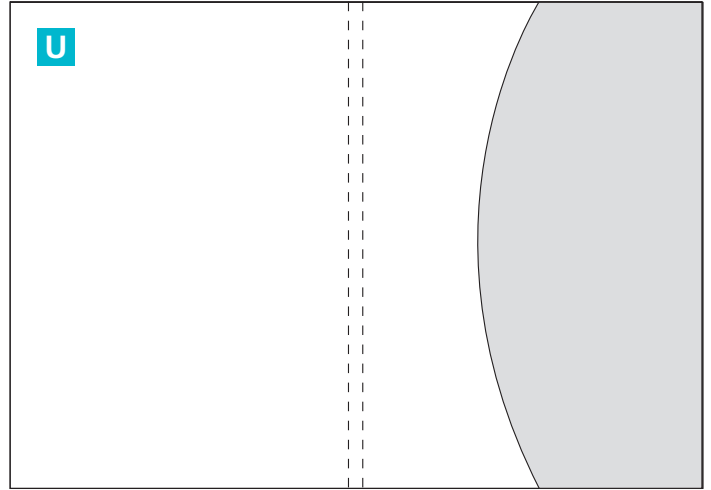

A4 | 4mm capacity glued pocket style

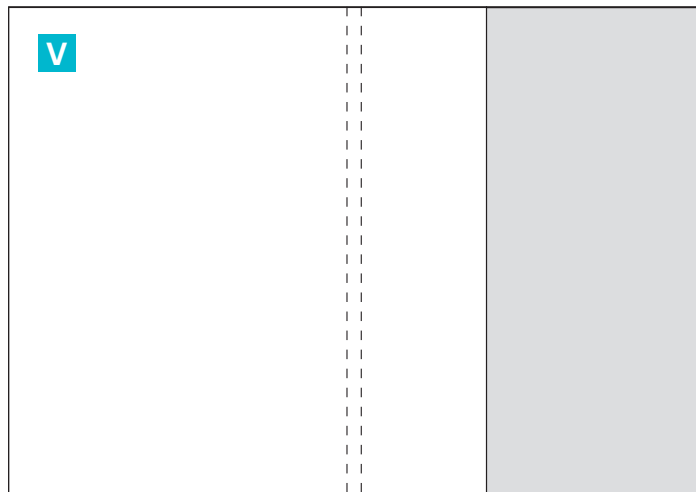

A4 | 4mm capacity glued pocket style

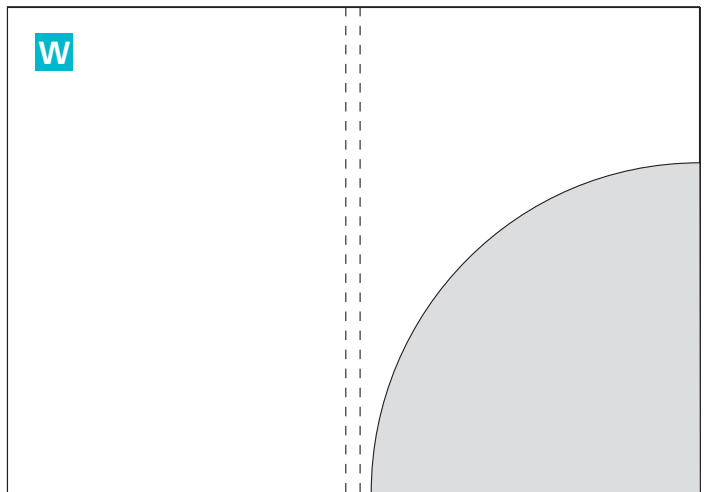

A4 | 10mm capacity glued pocket style

A4 capacity folders

Clipped together style

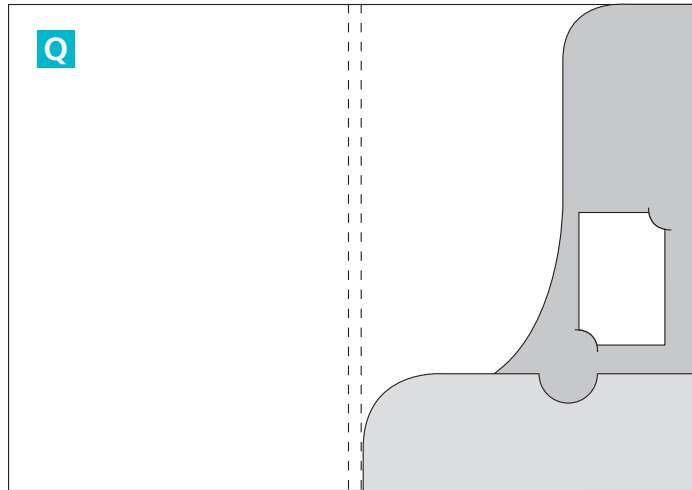

A4 | 4mm capacity clip together style (portrait business card)

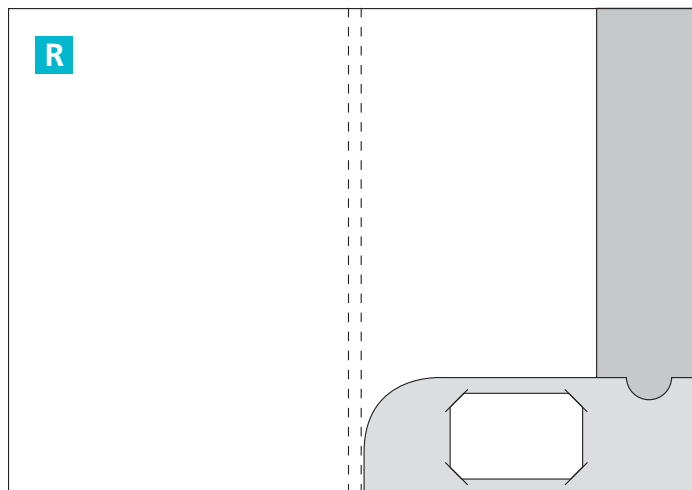

A4 | 4mm capacity clip together style (landscape business card)

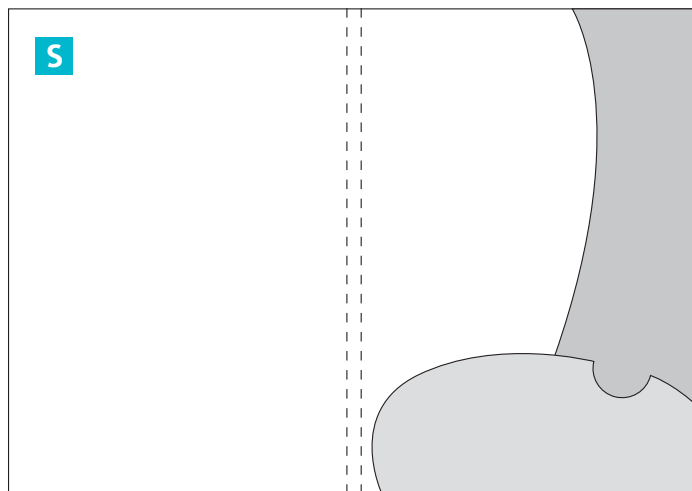

A4 | 6mm capacity clip together style

A4 folders

Glued style

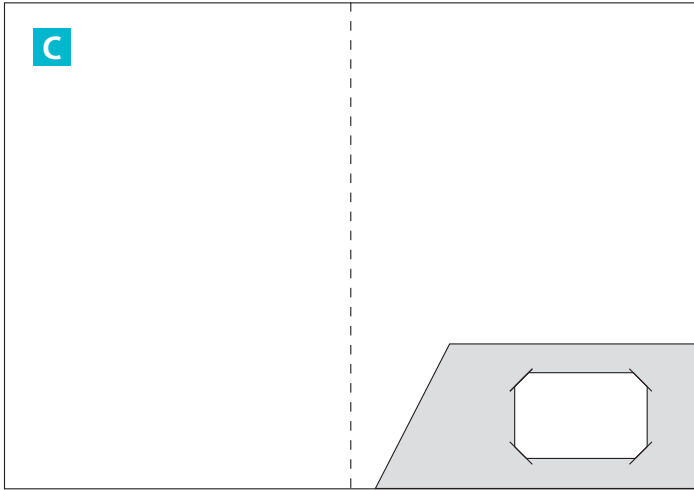

A4 | Glued pocket style (landscape business card)

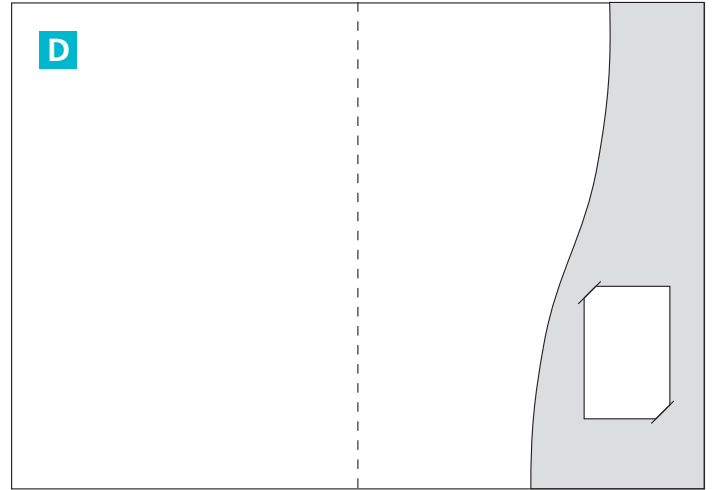

A4 | Glued pocket style (portrait business card)

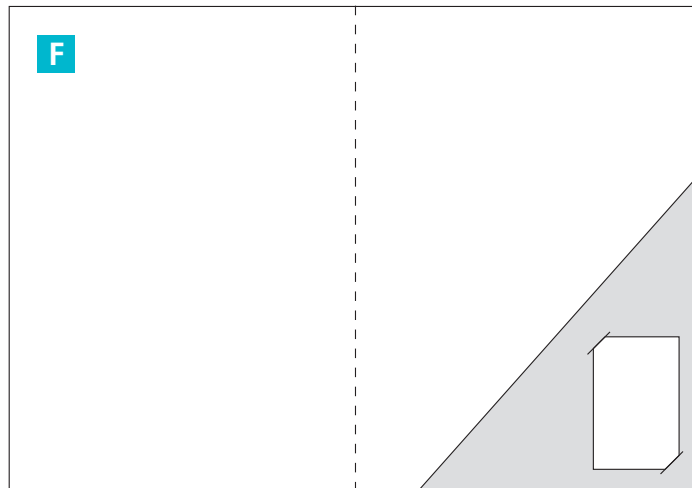

A4 | Glued pocket style (portrait business card)

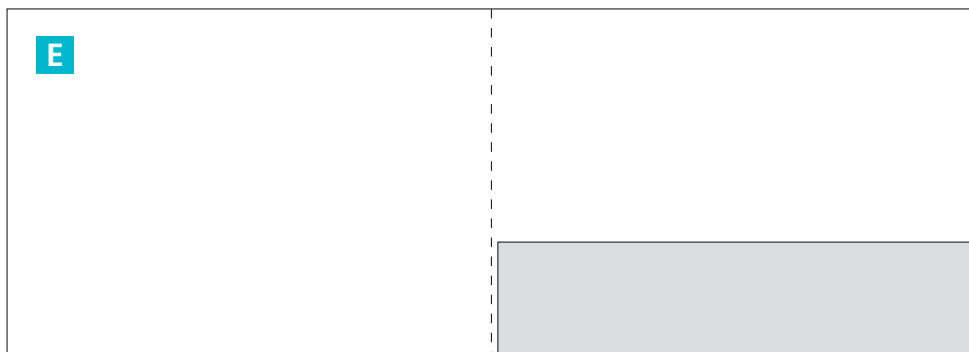

A4 | Glued pocket style

A4 folders

Clip together style

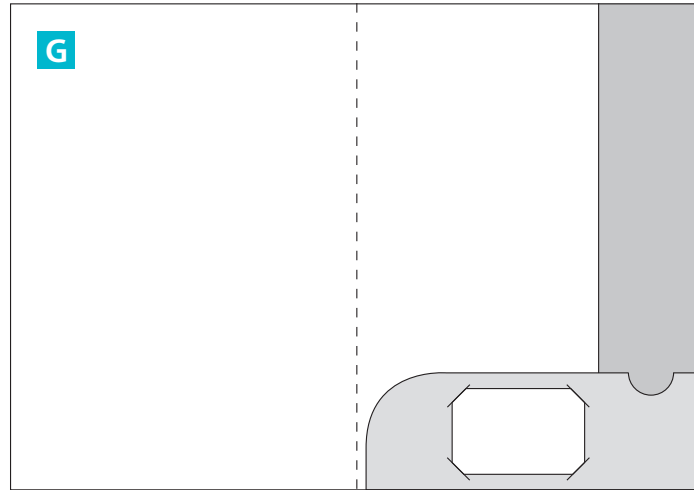

A4 | Clip together style (landscape business card)

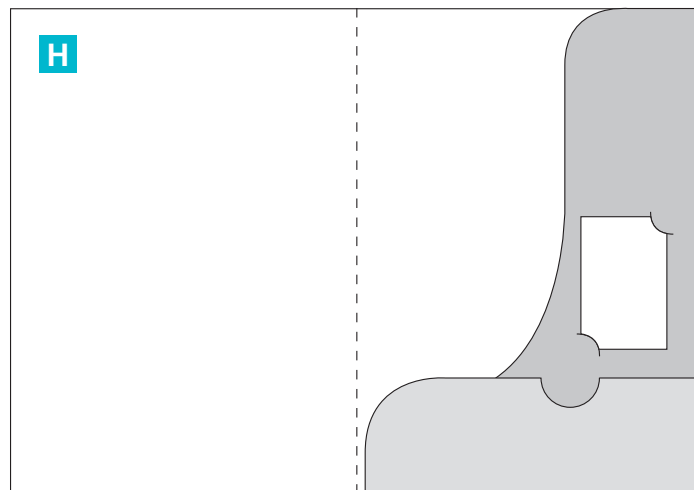

A4 | Clip together style (portrait business card)

Bolders

Multi page brochure folders 'bolders' - Glued style

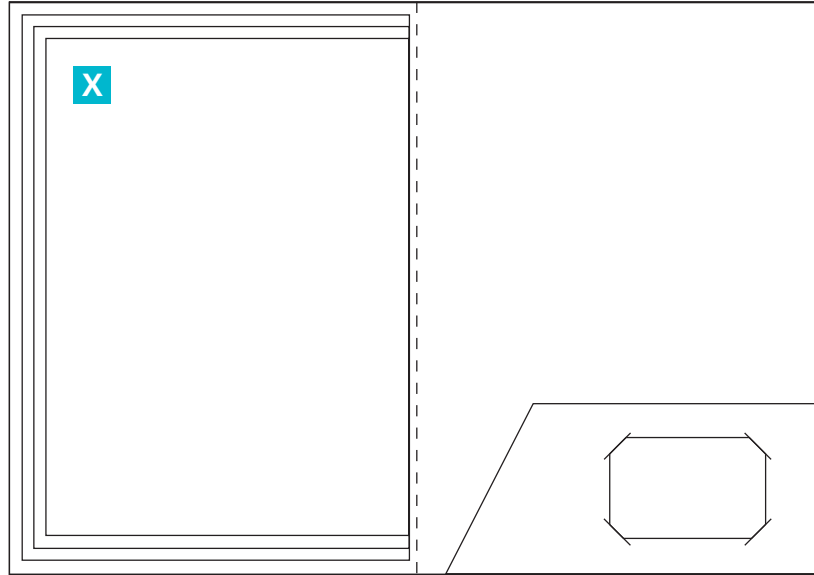

A4 | Glued pocket style (landscape business card)

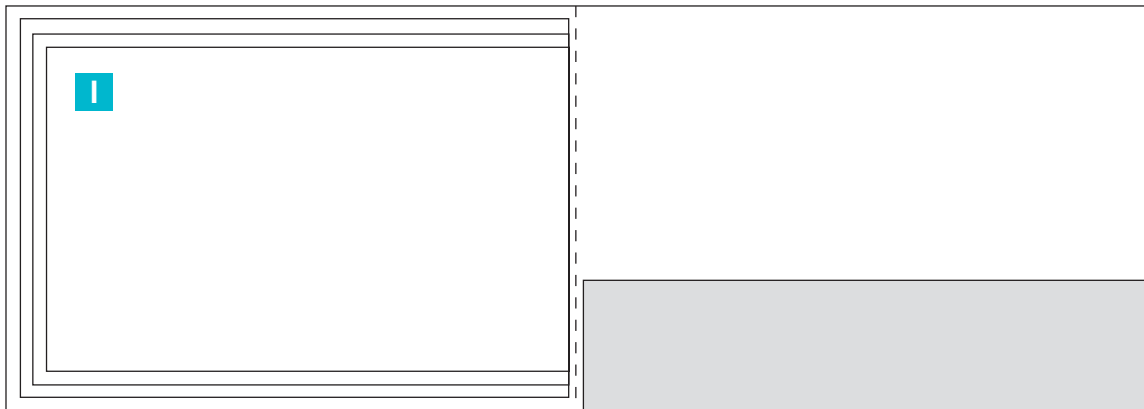

A4 | Glued pocket style